

Agregat pompowy OPA.0.09

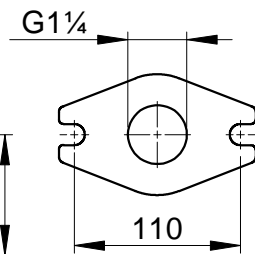

Widok „W”

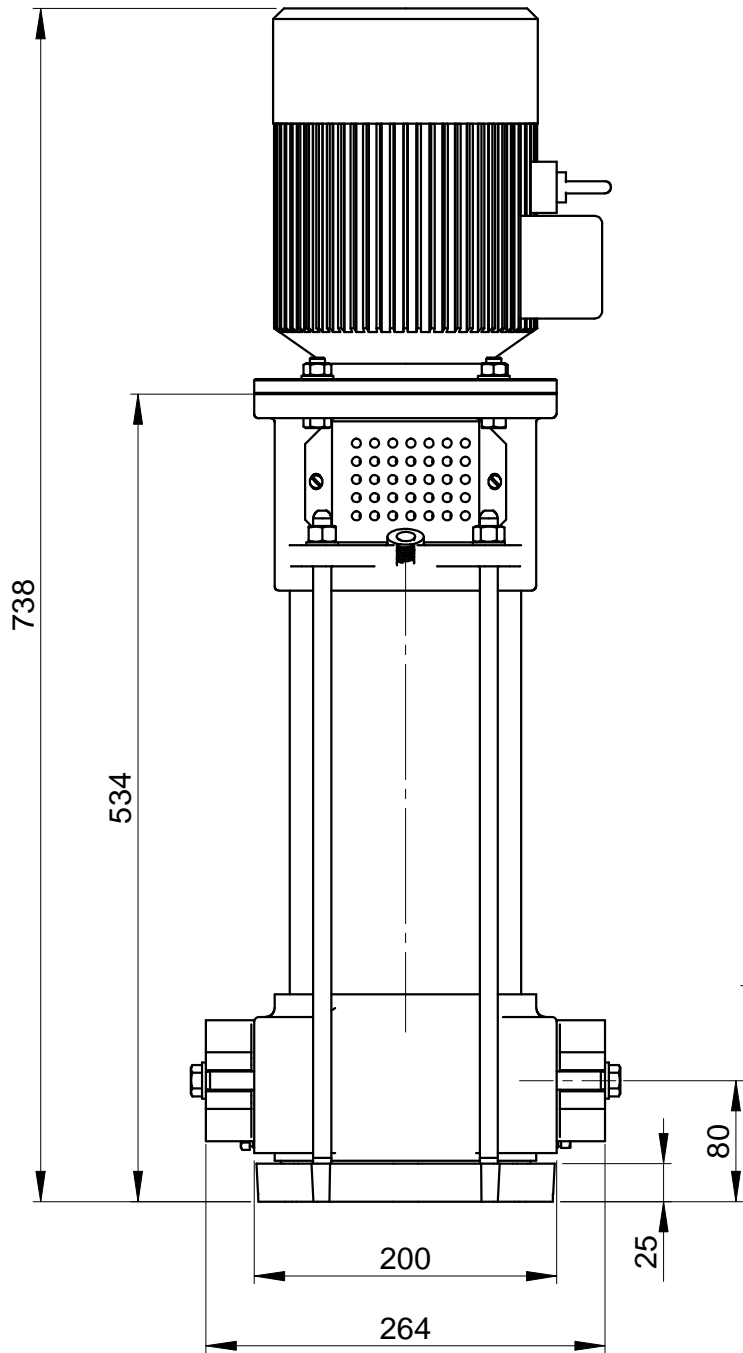